

Fabryka Elementów Budowlanych „G&A” Sp. z o.o.

Piersno 74; 55 - 311 Kostomłoty

NIP 913-13-91-282

www.gia.wroclaw.pl



Tel/fax 71-31-70-277

kom 601560480; 605226352

gia@gia.wroclaw.pl

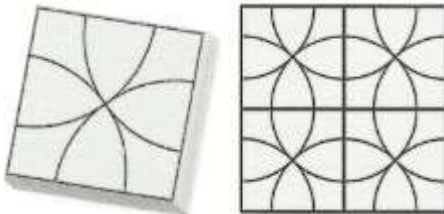
WZORY PŁYT CHODNIKOWYCH 05.2017:

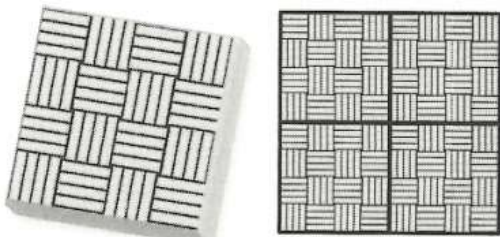
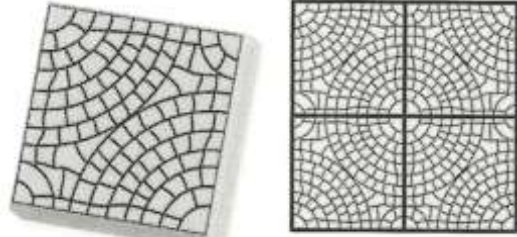
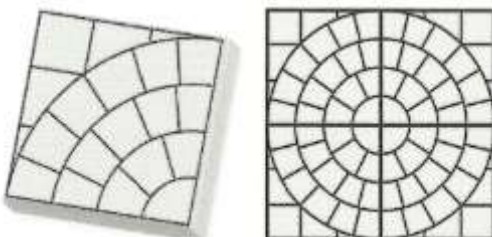
Wymiar	25/25/2,5cm 1m ² – 16szt; 1szt – 3,5kg	
Wzór	Kwiatek 	Koła dwa 

Wymiar	30/30/3cm 1m ² – 11szt; 1szt – 6kg	
Wzór	Czekoladka 	Bruk słońce 
	Bruk koło 	Deska 

WZORY PŁYT CHODNIKOWYCH LUB TARASOWYCH (pływające tarasy) 2015:

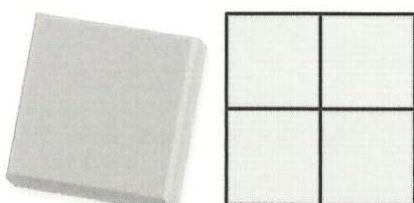
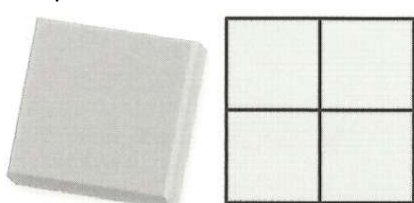

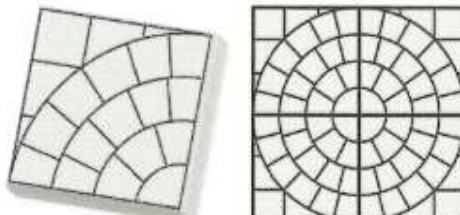
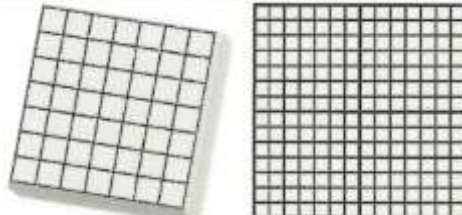
Wymiar	31,5/31,5/4cm 1m ² – 10,4 szt; 1szt – 9kg	30/30/4cm 1m ² – 11,1 szt; 1szt – 8,5kg
Wzór	Gładka 	Chropowata 

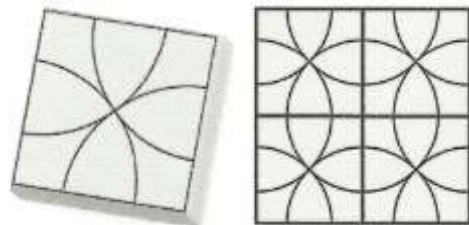
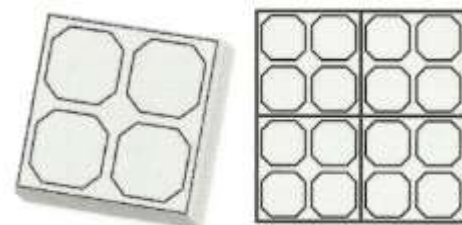
Wymiar	35/35/5cm 1m ² – 8szt; 1szt – 14kg	
Wzór	Bruk gładki 	Kwadracik 

	<p>Kwiatek</p> 	<p>Ośmiokąt</p> 
--	---	---

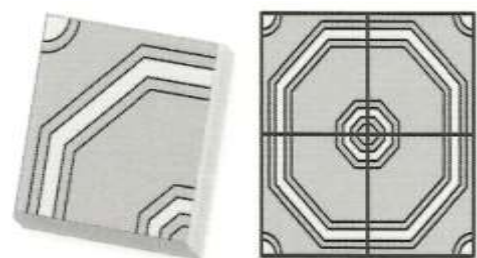
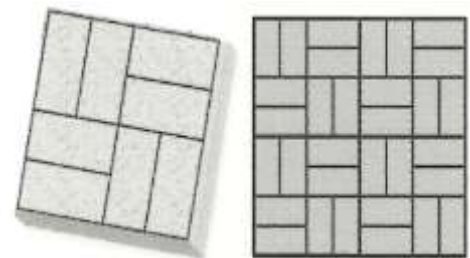
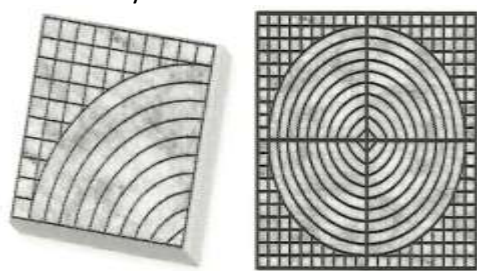
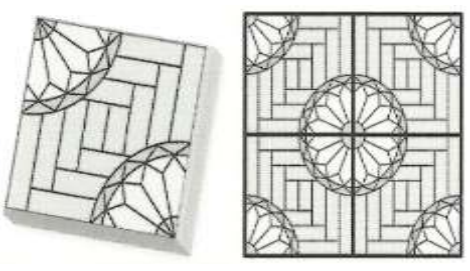
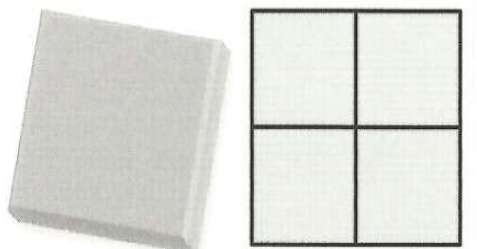
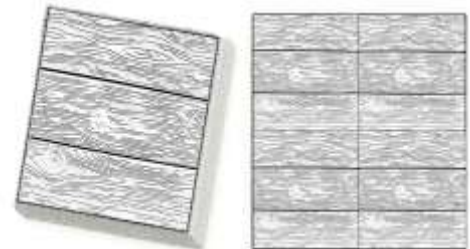
Wymiar - 40/40/5cm 1m² – 6szt; 1szt – 18/19kg

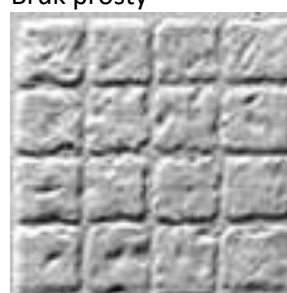
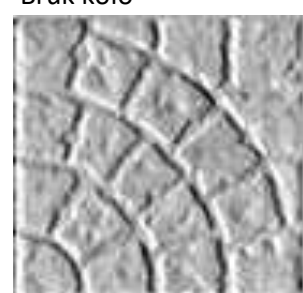
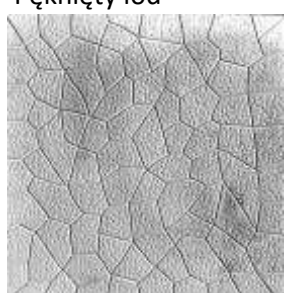
Wzór	<p>Ornament</p> 	<p>Paski dwa</p> 
	<p>Bruk drobny</p> 	<p>Rozeta</p> 
	<p>Gładka/Piaskowana*</p> 	<p>Deska</p> 

Wymiar	<p>45/45/3,8cm 1m² – 5szt; 1szt – 18kg ** 45/45/5cm</p>		
Wzór	<p>Bruk prosty</p> 	<p>Bruk koło</p> 	<p>Pęknięty lód</p> 
	<p>Jodełka</p> 	<p>Kamień wezyra**</p> 	

Wymiar	50/50/5cm 1m ² – 4szt; 1szt – 27kg	
Wzór	Paski trzy	Wąż
	Gładka/Piaskowana*	

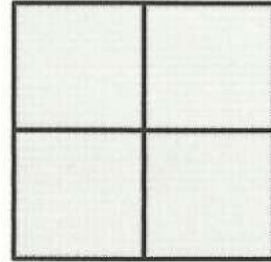
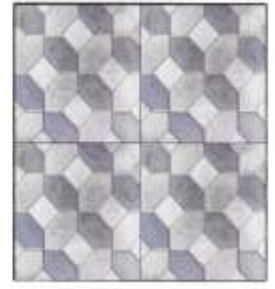
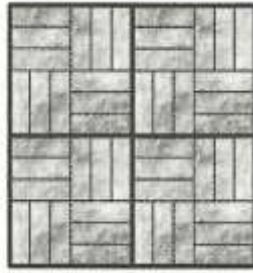

*Piaskowanie lub płukanie za dodatkową opłatą (1,85 zł brutto/szt)

Cennik brutto/szt*

Płyty chodnikowe	Szary		Czerwony, brąz		Żółty, piaskowy, grafit		Szacunkowe parametry
	niezbr.	zbrojone	niezbr.	zbrojone	niezbr.	zbrojone	
50/50/5cm	11,07	13,57	12,05	14,55	12,55	15,05	1m ² =4szt; 1szt=27kg
45/45/3,8cm 45/45/5cm	9,84	12,34	10,58	13,08	11,07	13,57	1m ² =5szt; 1szt=18kg, 50szt/paleta
40/40/5cm	7,38	9,88	8,12	10,62	8,61	11,11	1m ² =6,25szt; 1szt=18kg; 44szt/paleta
35/35/5cm	6,77	9,27	7,38	9,88	7,75	10,25	1m ² =8,16szt; 1szt=14kg; 90szt/paleta
31,5/31,5/4cm 30/30/4cm	5,00	7,50	5,60	8,10	6,00	8,50	1m ² =10,4-11,1szt; 1szt=9,5-9kg; szt/pal
30/30/3cm	4,92	-	5,54	-	5,90	-	1m ² =11,1szt; 1szt=6kg; 140szt/paleta
25/25/2,5cm	2,83	-	2,95	-	3,08	-	1m ² =16szt; 1szt=3,5kg; 120x2 szt/paleta

*Podane ceny nie zawierają kosztów transportu.